

# MONZA TRÄDGÅRDSBORD

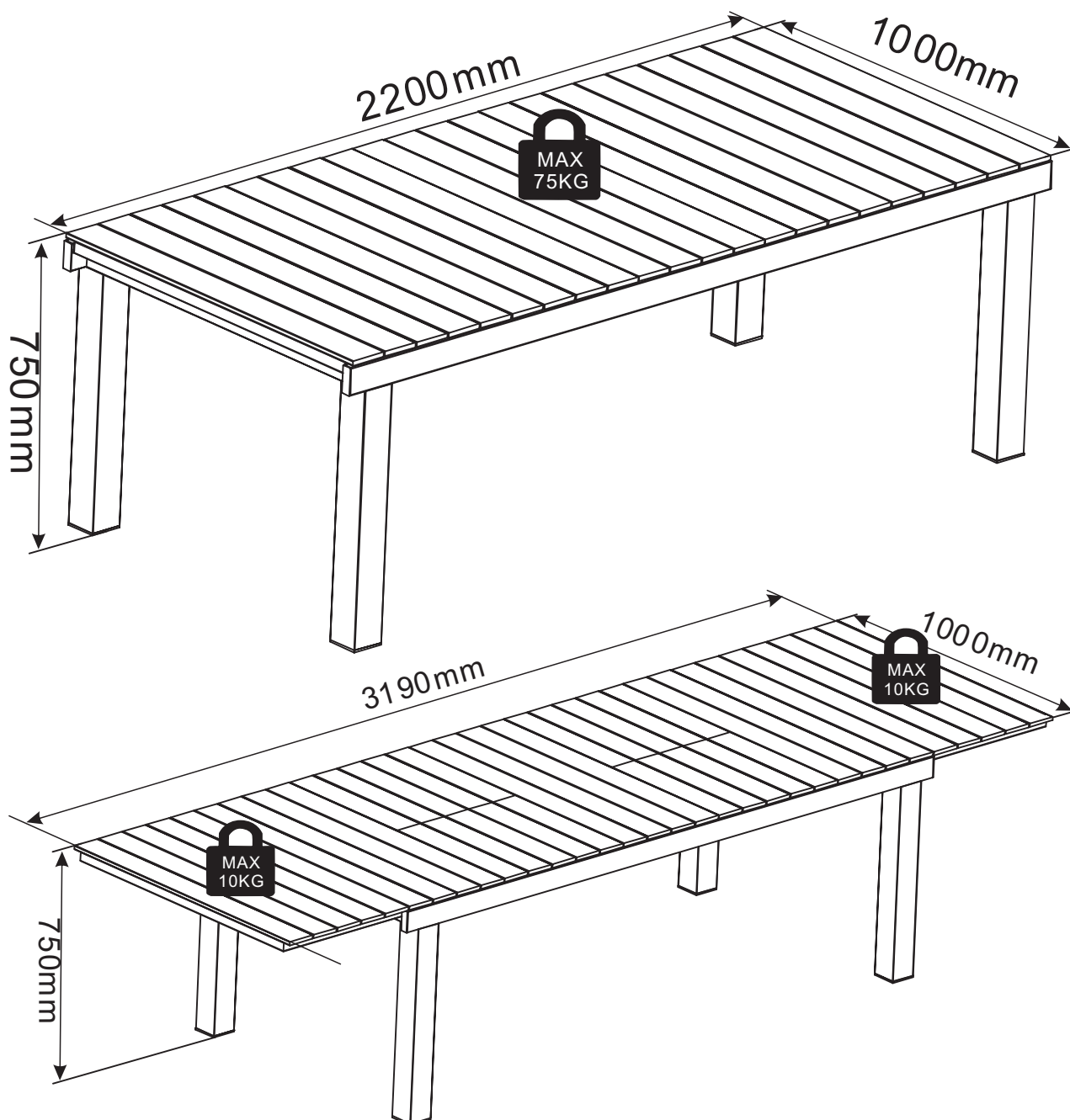

Först sätt i alla skruvarna i hålen, sedan dra åt dem

M1711370

1-6

**mi**o

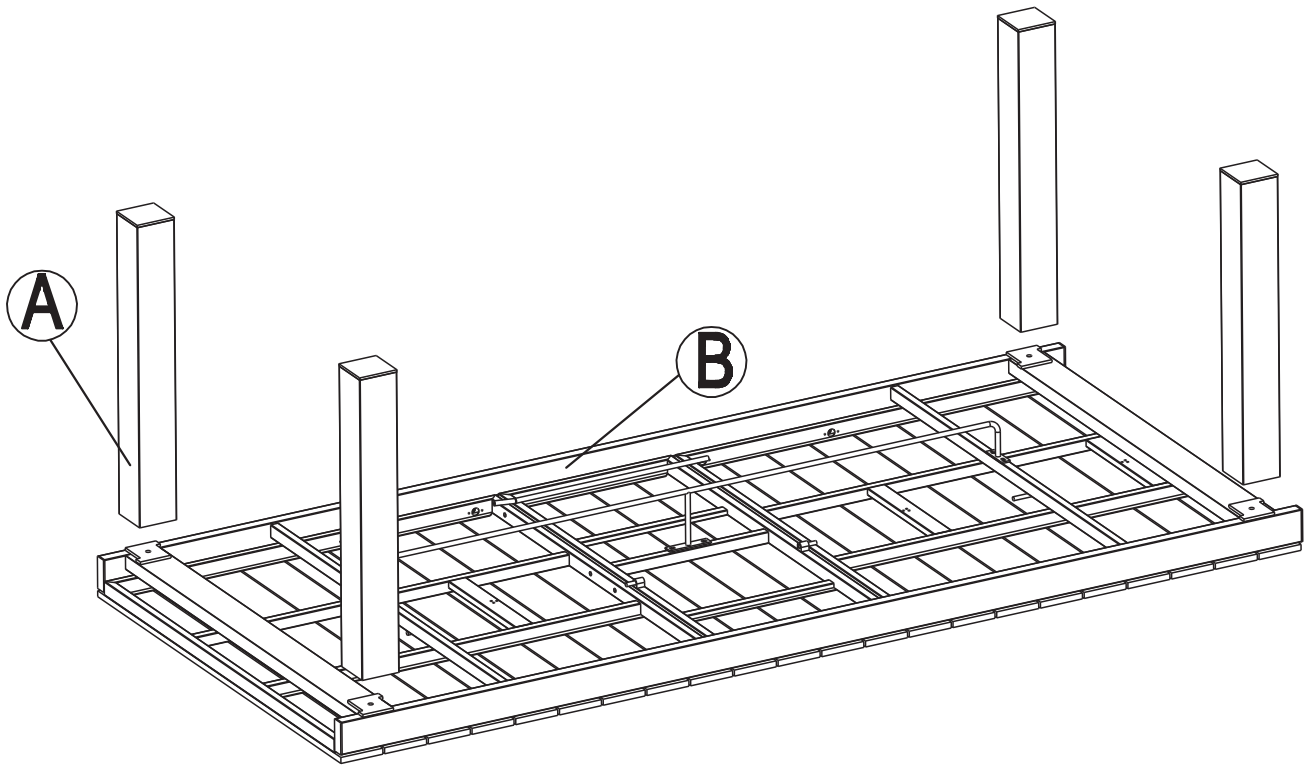

<b>A</b>	<b>4PCS</b>
<b>B</b>	<b>1PC</b>

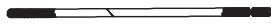
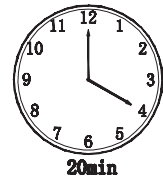
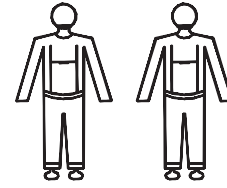
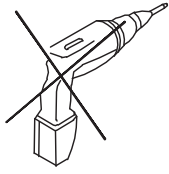

**M10X660mm**

**4\*B1**

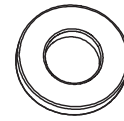

**M6x20mm**

**4\*B2**



**Ø 10mm**

**4\*B3**

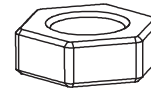

**M10 mm**

**8\*B4**

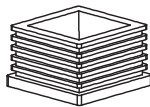

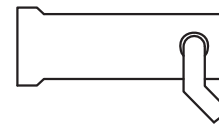

**60X60mm**

**4\*B5**

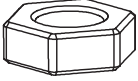

**1\*B6**

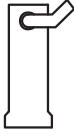
 <p>M10mm 4*B4</p>	 <p>M10X660mm 4*B1</p>	 <p>1*B6</p>
---	---	---

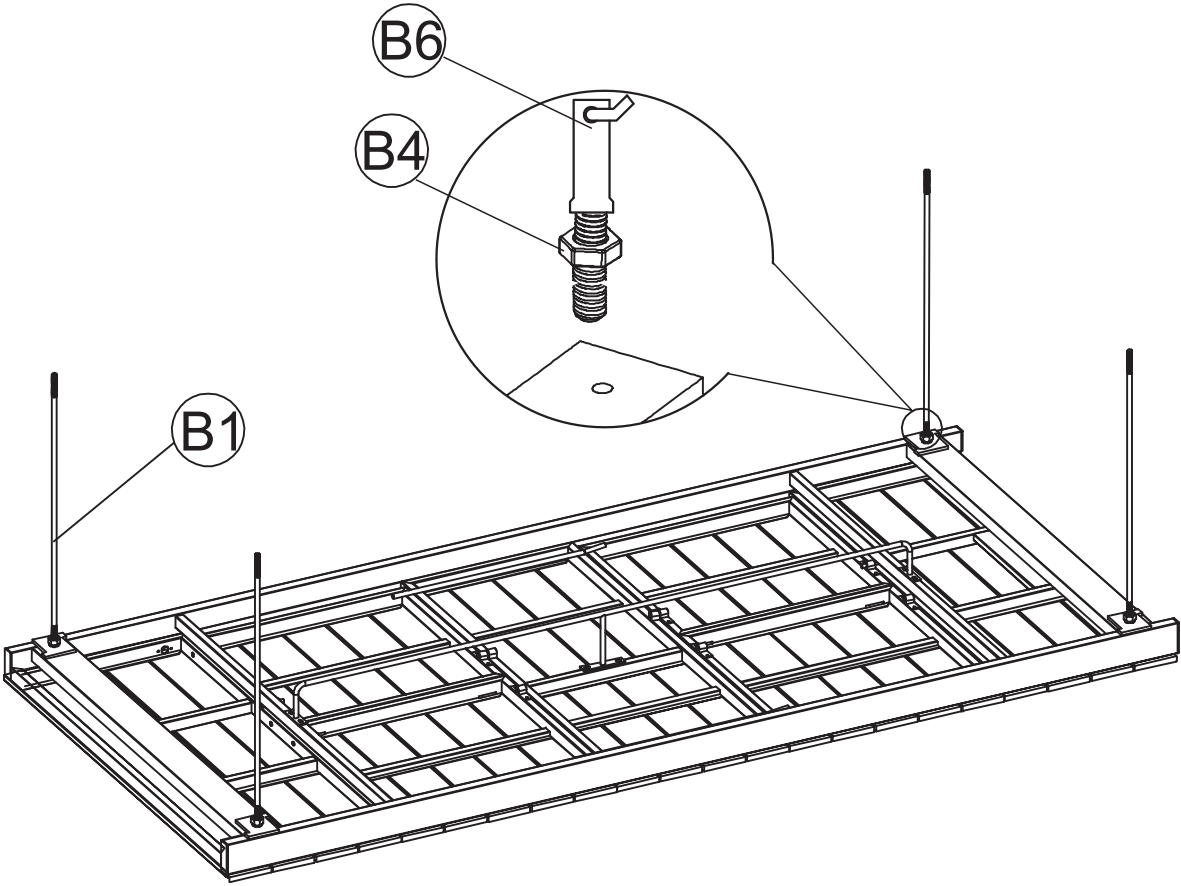



Ø10mm 4\*B2



Ø10mm 4\*B3

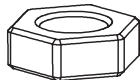

M10mm 4\*B4

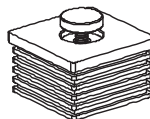

85X85mm 4\*B5



1\*B6

