

Monteringsanvisning

STORE

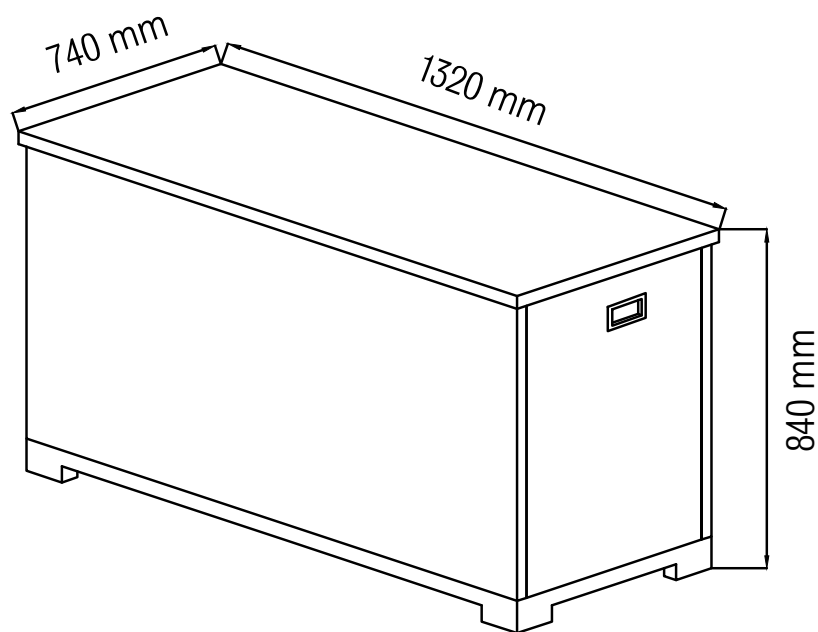

Du behöver

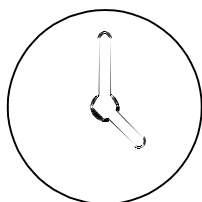

ca 25 Minuter

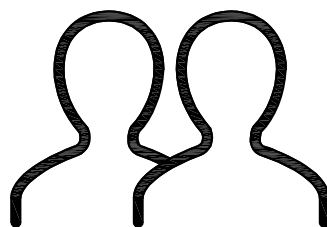

2 personer

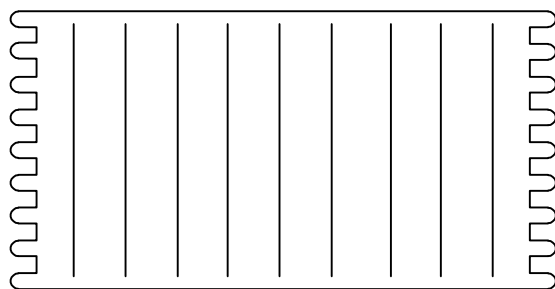
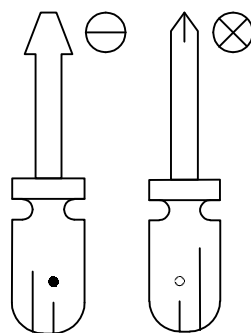
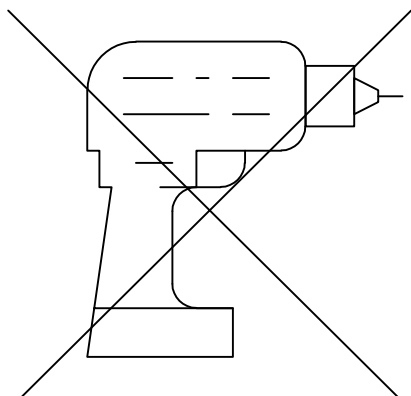

Lägg din produkt på ett mjukt underlag när du monterar



Har du frågor om monteringen av dina möbler?

Hör av dig till din Mio-butik eller ring till vår kundservice 020 66 44 00

Ingående delar

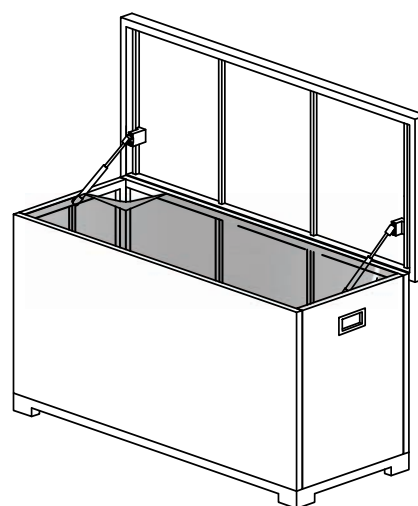
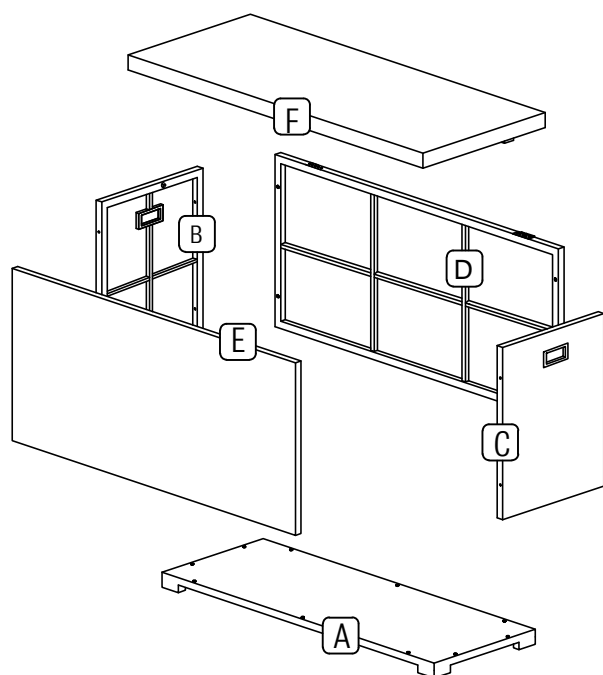

	QTY	mm
A	1	1255x670x50
B	1	760x625x40
C	1	760x625x40
D	1	1255x760x40
E	1	1255x760x25
F	1	1320x740x60

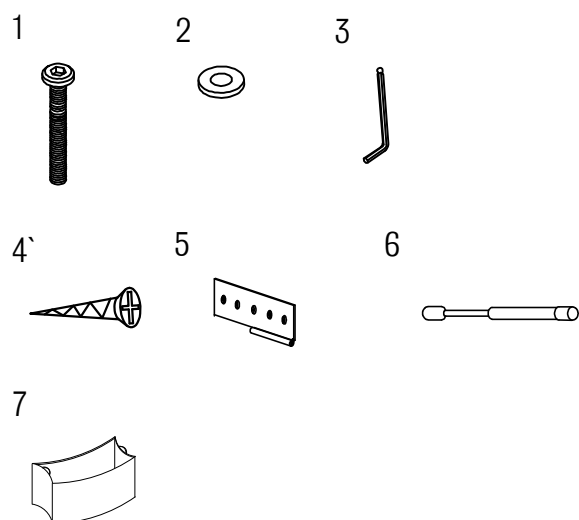

Nr	QTY	mm
1	18	M6x40
2	18	Ø6x16x1.5
3	1	K4x100x20
4	5	Ø4x25
5	1	80x28x7
6	2	Dia25x172
7	1	1230x650x770

Montering

Följ instruktionerna steg för steg

1. Fäst skruvarna till 70%

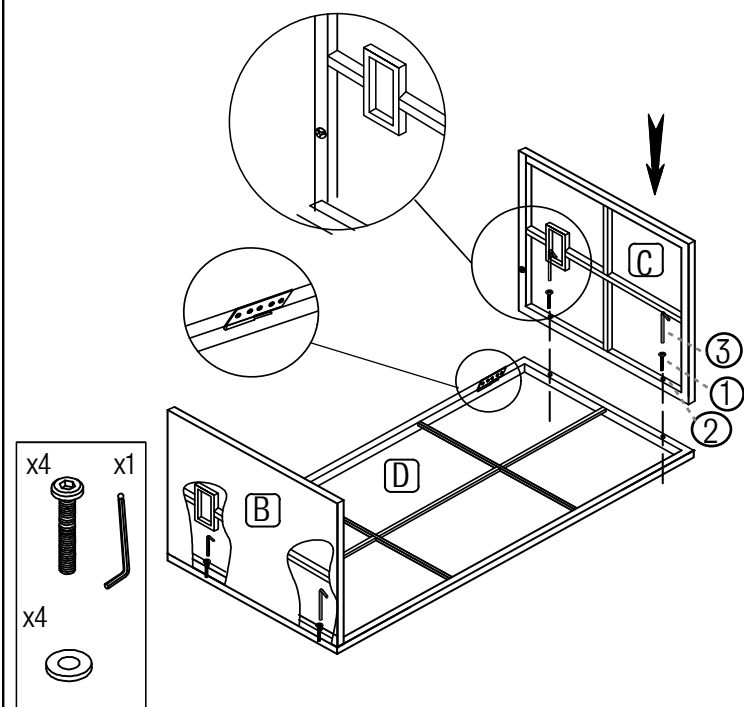

2. Fäst skruvarna till 70%

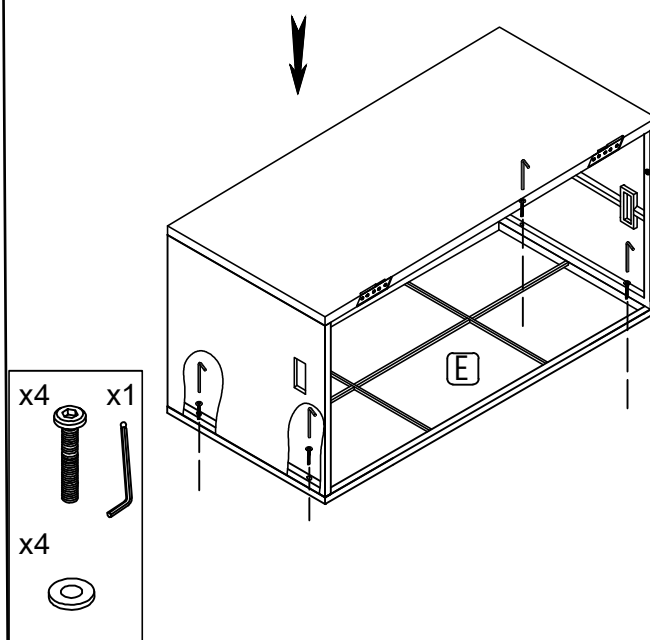

3. Fäst skruvarna till 70%

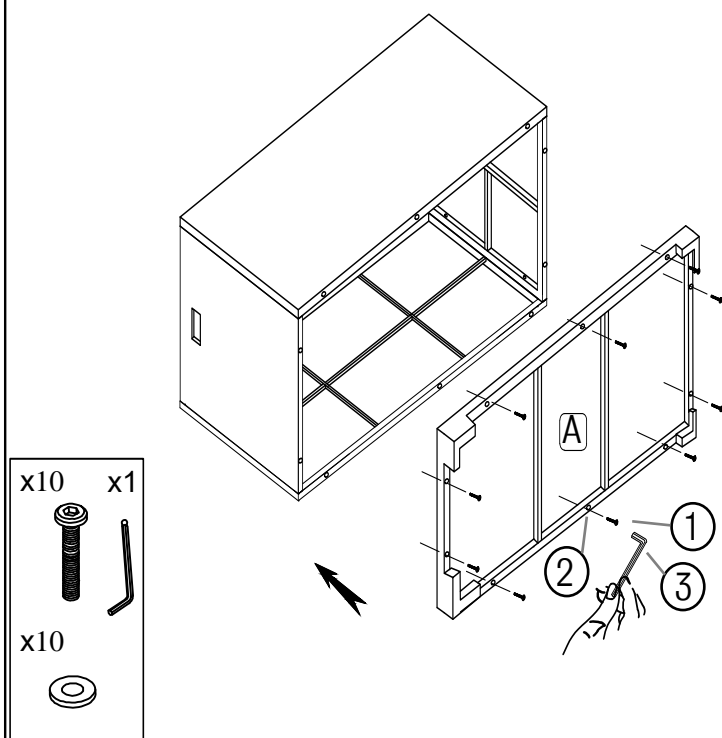

4. Fäst skruvarna till 100%

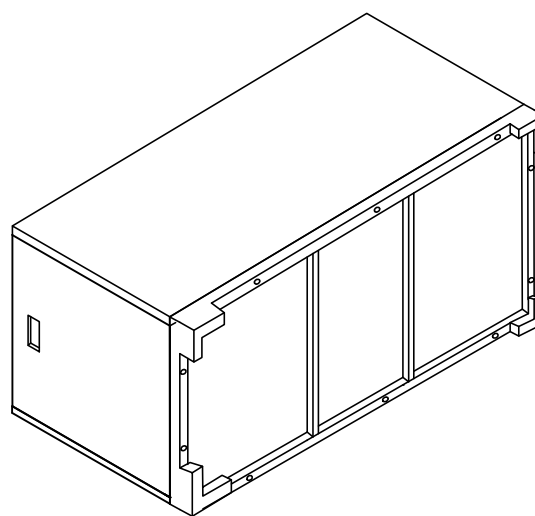

Montering

Följ instruktionerna steg för steg

5.

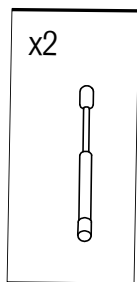
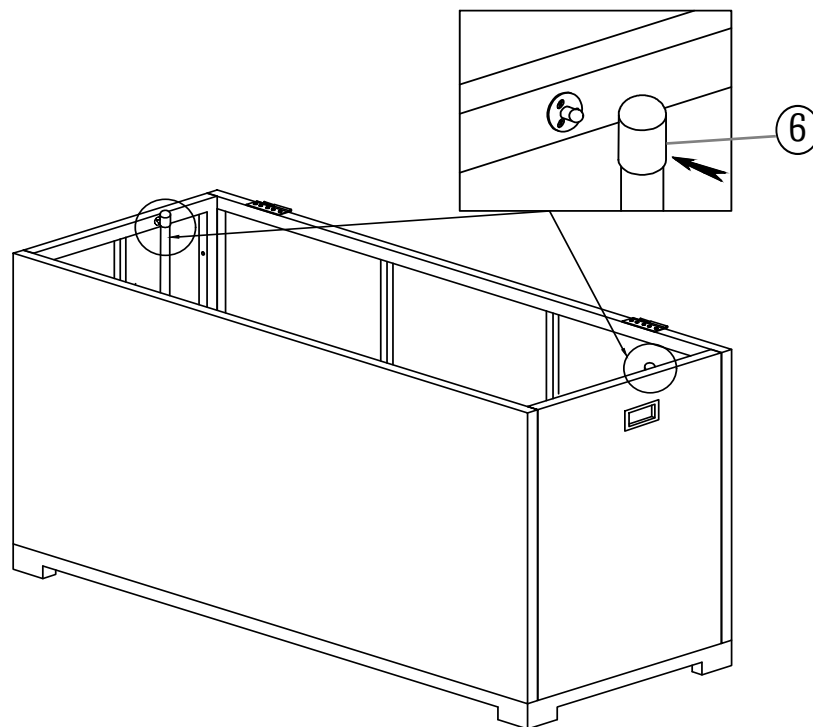

6.

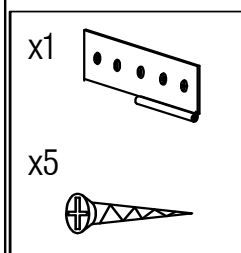
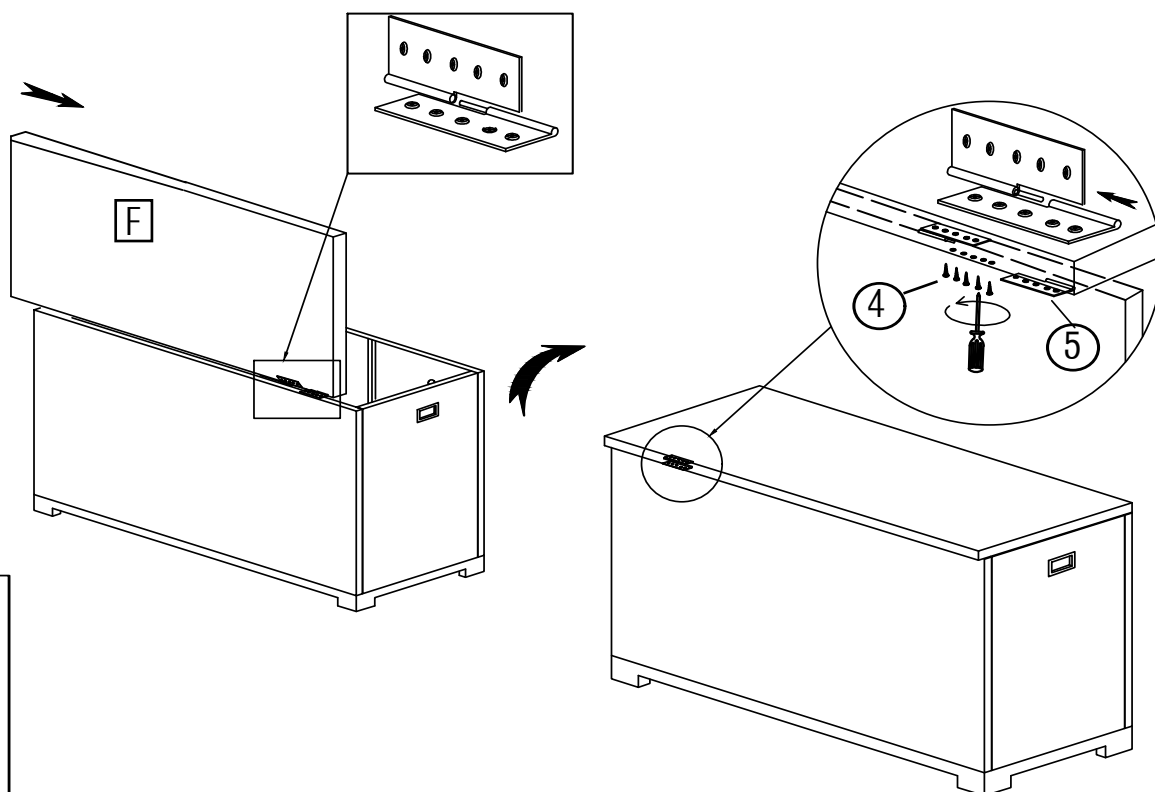

Montering

Följ instruktionerna steg för steg

7.

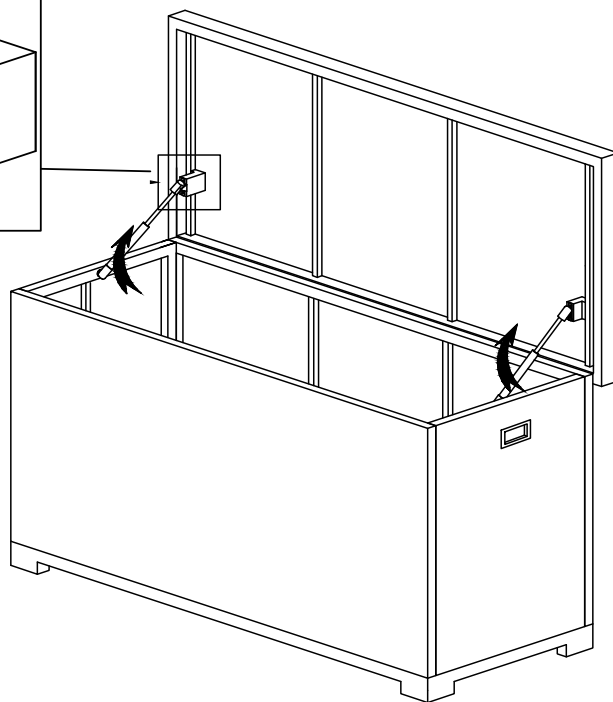
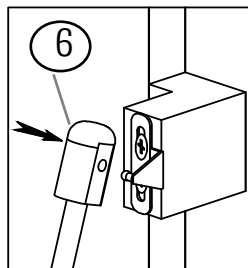

x2



8.

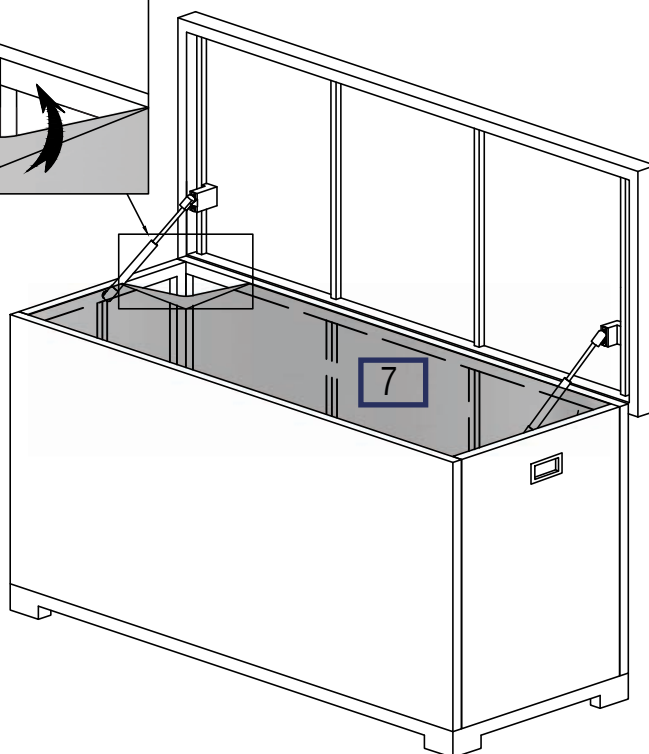
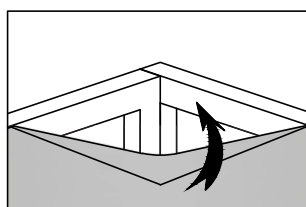

x1

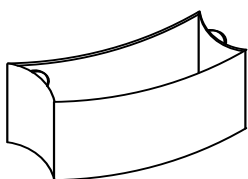



Maxvikt

