

Du behöver

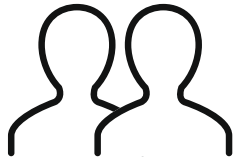

ca 0,5 timmar



2 personer

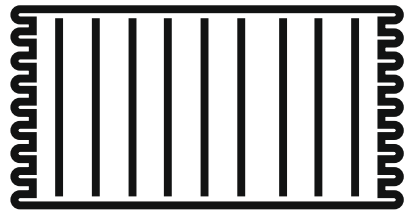
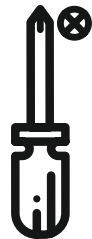
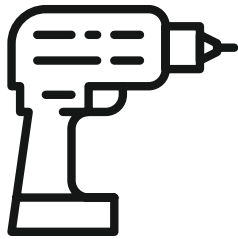

Lägg din produkt på ett mjukt underlag när du monterar



Har du frågor om monteringen av dina möbler?
Hör av dig till din Mio-butik eller ring till vår kundservice 020 66 44 00

Monteringsanvisning

SIERRA

Hörnsoffa 2+3+sch assembly

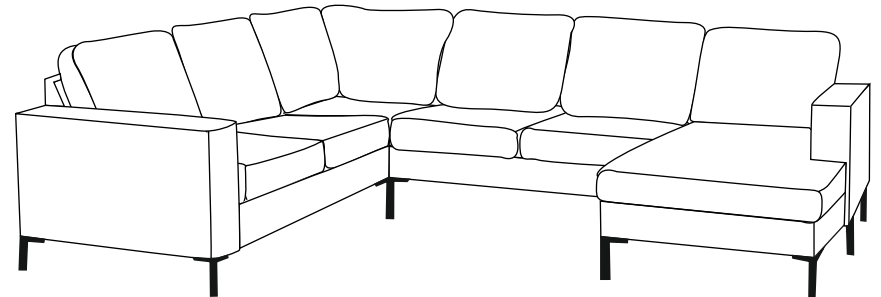

Ingående delar

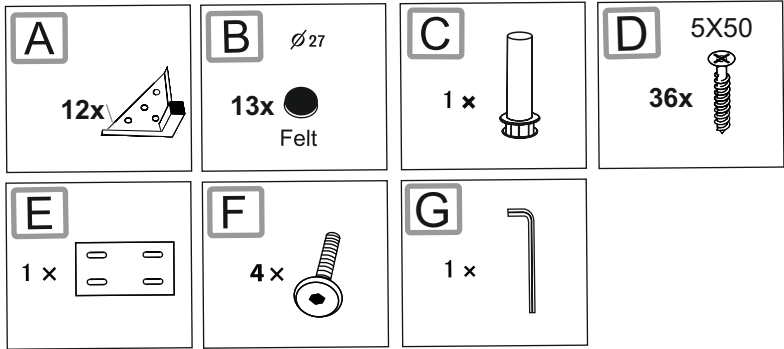

Montering

Följ instruktionerna steg för steg

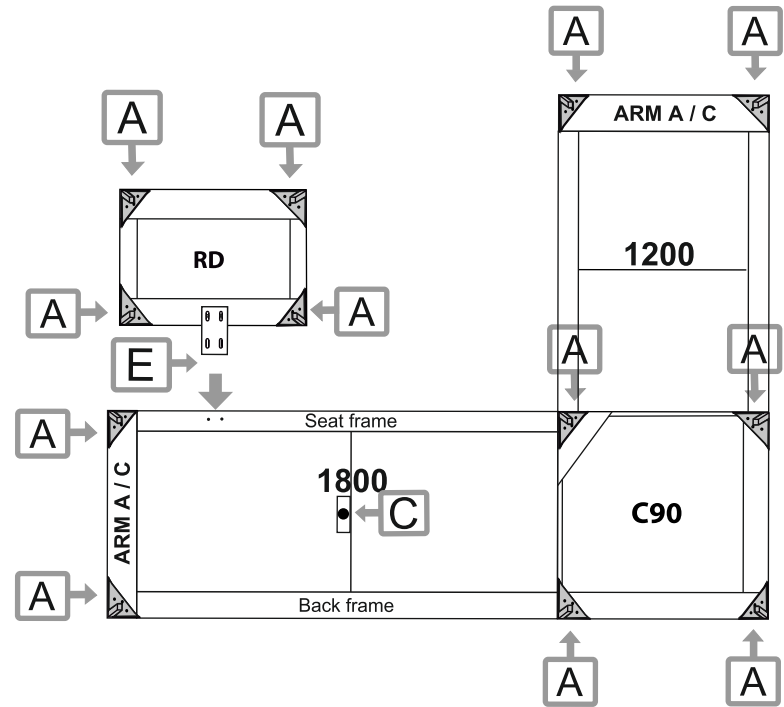
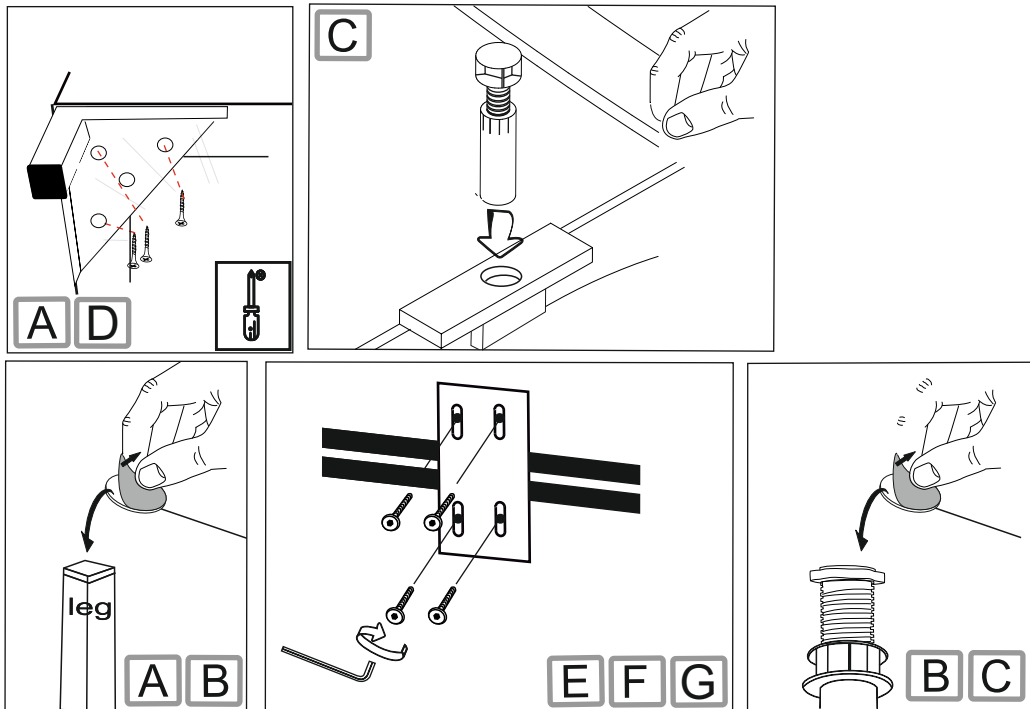

Important!
screw it 5-6mm
above the
ground

leave 5-6mm

C Connect plastic support legs to the pre drilled holes.

