

Monteringsanvisning

GORDON

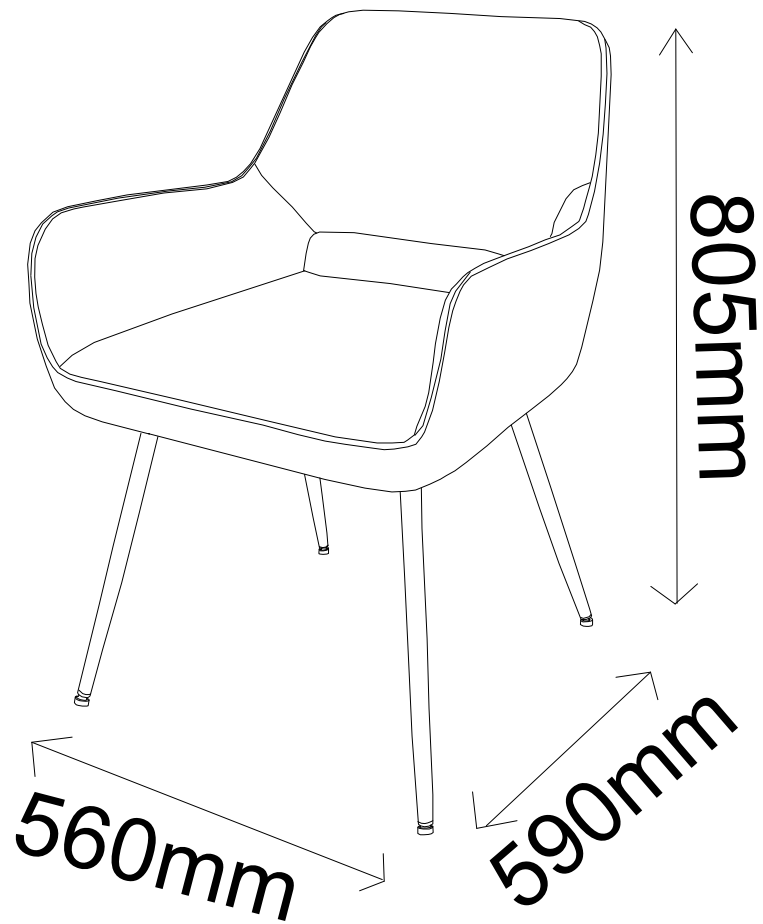

Du behöver

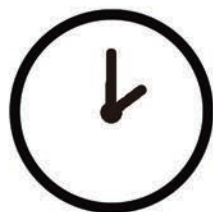

ca 15 minut



1 personer

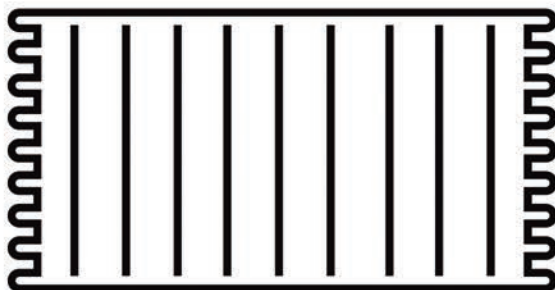

Lägg din produkt på ett mjukt underlag när du monterar



Har du frågor om monteringen av dina möbler?

Hör av dig till din Mio-butik eller ring till vår kundservice 020 66 44 00

Ingående delar

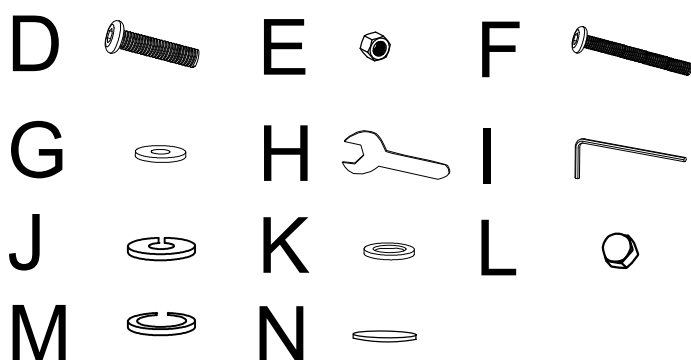
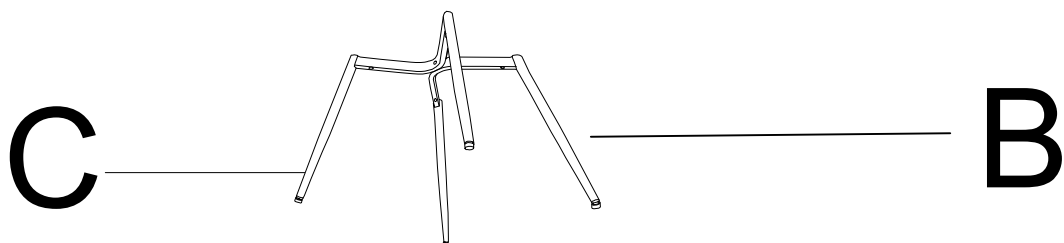
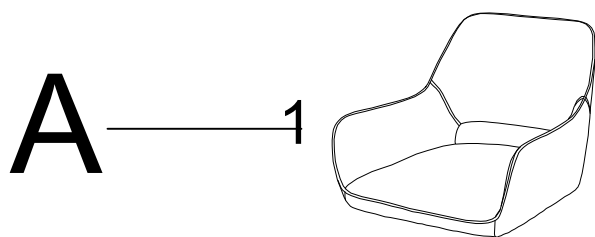

| Nr | QTY | mm |
|----|-----|-------|
| D | 1 | M8× |
| E | 4 | M8 |
| F | 1 | M6×50 |
| G | 1 | M6 |
| H | 1 | M8 |
| I | 1 | M5 |
| J | 4 | M6 |
| K | 2 | M8 |
| L | 1 | M8 |
| M | 2 | M8 |
| N | 4 | Ø15 |

Montering

Följ instruktionerna steg för steg

1

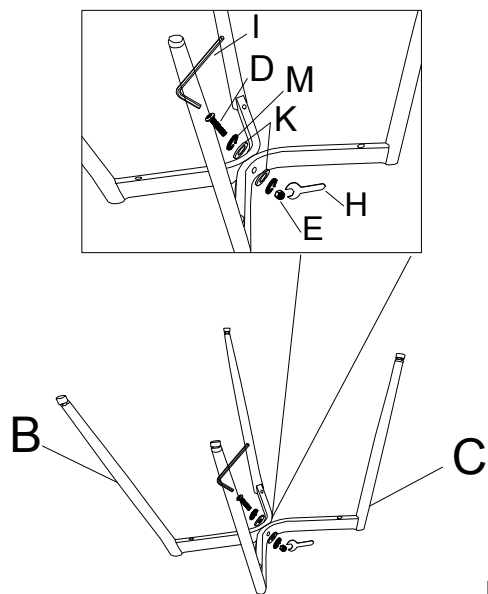

2

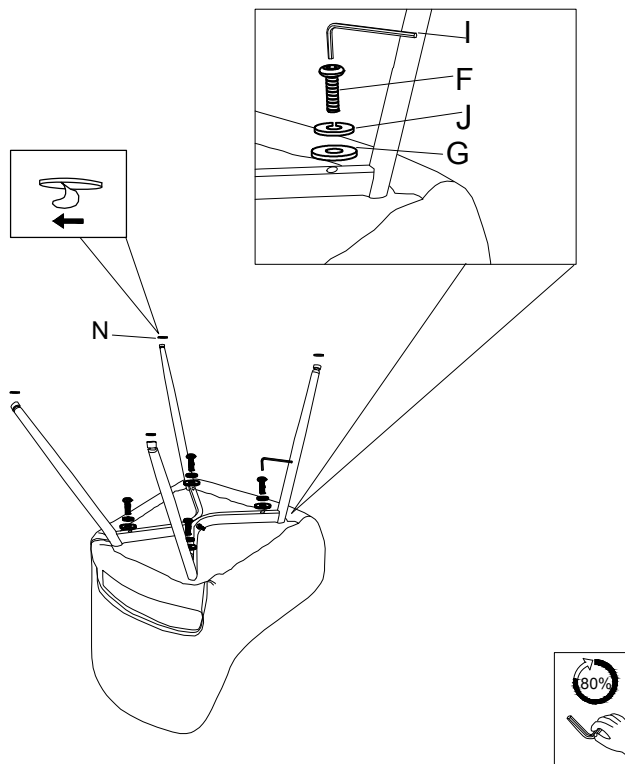

3

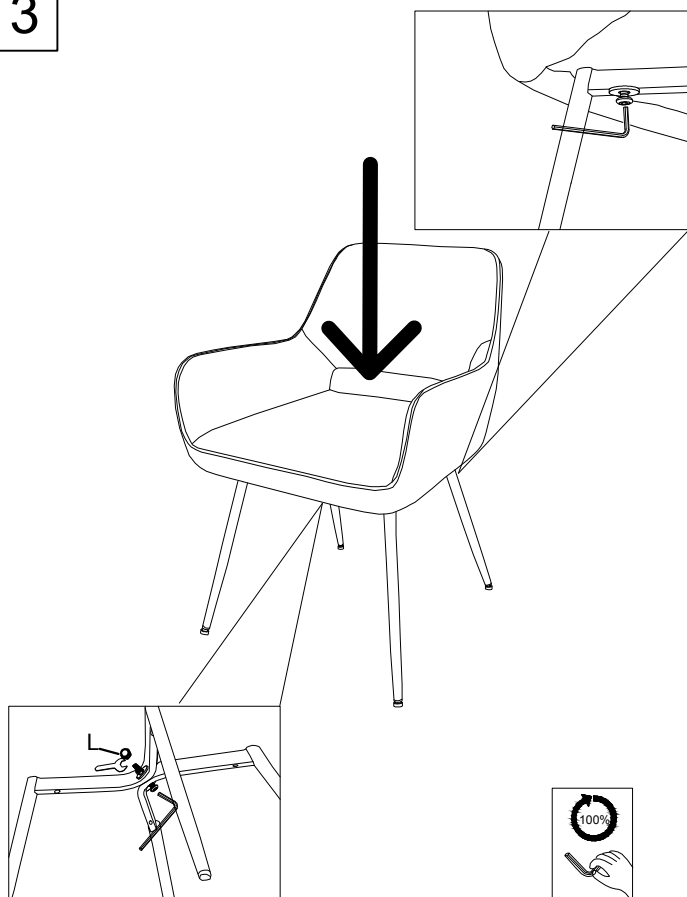

4

