

Monteringsanvisning

Kingston 3so;

2so;1so;Pall;Ach

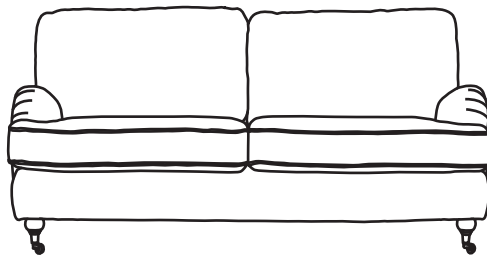
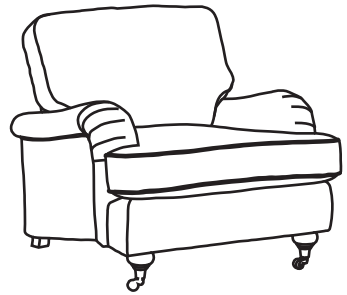

Du behöver



ca 30 minuter



2 personer

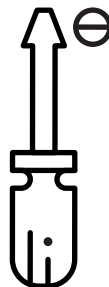
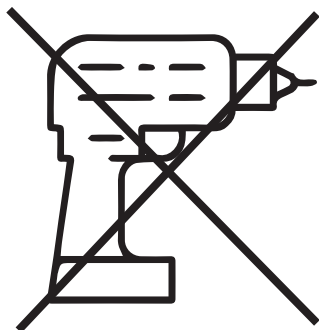

Har du frågor om monteringen av dina möbler?

Hör av dig till din Mio-butik eller ring till vår kundservice 020 66 44 00

Ingående delar

3so;2so;1so;Ach

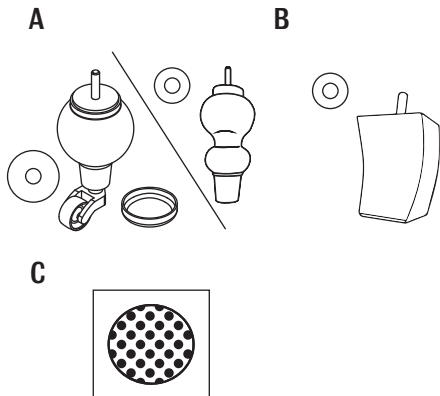

Nr	QTY	mm
A	2	H:140
B	2	H:90
C	4	

Pall

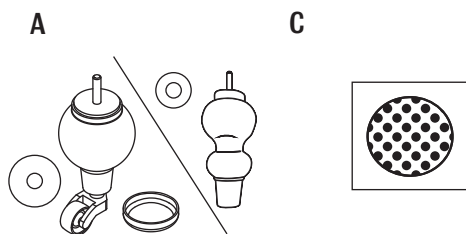

Nr	QTY	mm
A	4	H:140
C	4	

Montering

Följ instruktionerna steg för steg

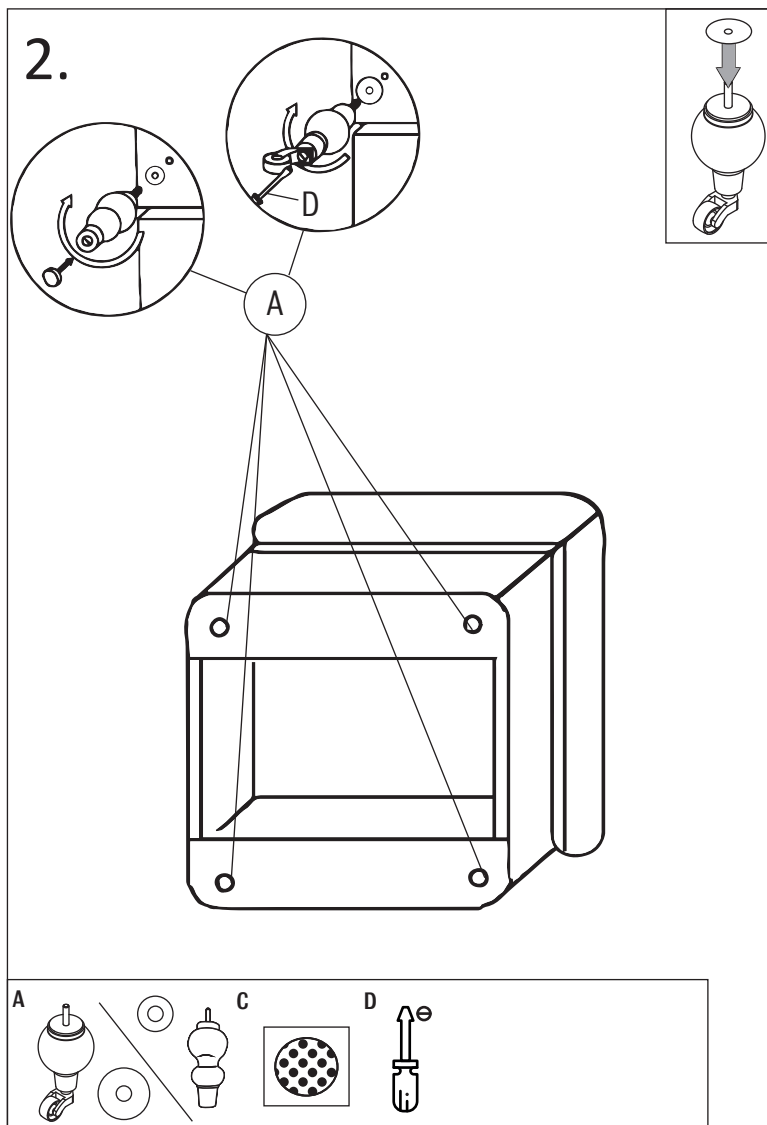

Montering

Följ instruktionerna steg för steg

